

Model No.: YSM-2388ARGBC
8mm Pitch RED/GREEN/BLUE Tripple Color
Dot Matrix

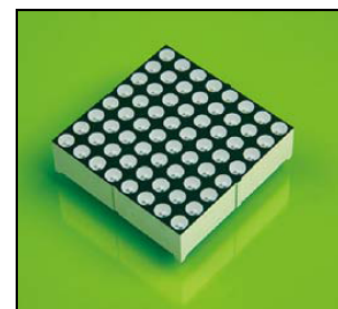

Applications:

- ☑ Moving Message Display
- ☑ Banking Board
- ☑ Digital Display
- ☑ Full Color Display
- ☑ Score Boards

LED Chip Absolute Maximum Ratings: (Ta=25°C)

Parameter	Symbol	Red	Green	Blue	Unit
Forward curret	I _F	20	20	20	mA
Peak forward current(Duty Cycle= $\frac{1}{10}$, 10KHz)	I _{PF}	30	30	30	mA
Reverse voltage (V _R =5V)	I _R	10	10	10	μ A
Operating temp	T _{OPR}	-25 - 85	-25 - 85	-25 - 85	°C
Storage temp	T _{STG}	-30-85	-30-85	-30-85	°C
Peak Emission Wavelenength	λ PH	625	527.5	467.5	nm

* Soldering Bath: not more than 5 seconds @260 °C.The bottom ends of the plastic reflector should be at least 2mm above the solder surface

Soldering Iron: not more than 3 seconds @300 °C under 30W

LED Chip Typical Electircal & Optical Chara Qeristics: (Ta=25°C)

ITEMS	Color	Symbol	Condition	Min.	Typ.	Max.	Unit
Forward Voltage	Red	V _F	I _F =20mA	1.9	2.0	2.1	V
	Green			3.0	3.2	3.4	
	Blue			3.0	3.2	3.4	
Luminous Intensity	Red	I _V	I _F =20mA	100	150	180	mcd
	Green			400	450	500	
	Blue			50	80	120	
Wavelenength	Red	Δ λ	I _F =20mA	620	623	625	nm
	Green			525	525	527.5	
	Blue			465	466	467.5	
Light Degradation after 1000 hours	Red	-4.68% ~ -8.27%					
	Green	-11.37% ~ -15.30%					
	Blue	-12.47% ~ -16.81%					

General Electronics Tech Co., Ltd.

E-Mail: support@geeetech.com MSN: Rockylou84@hotmail.com

Tel: +86 755 2658 4110 Fax: +86 755 2658 4074 Phone: +86 137 2877 2361

Mechanical Dimensions:

- All dimension are in mm, tolerance is $\pm 0.2\text{mm}$ unless otherwise noted
- An epoxy meniscus may extend about 1.5mm down the leads.

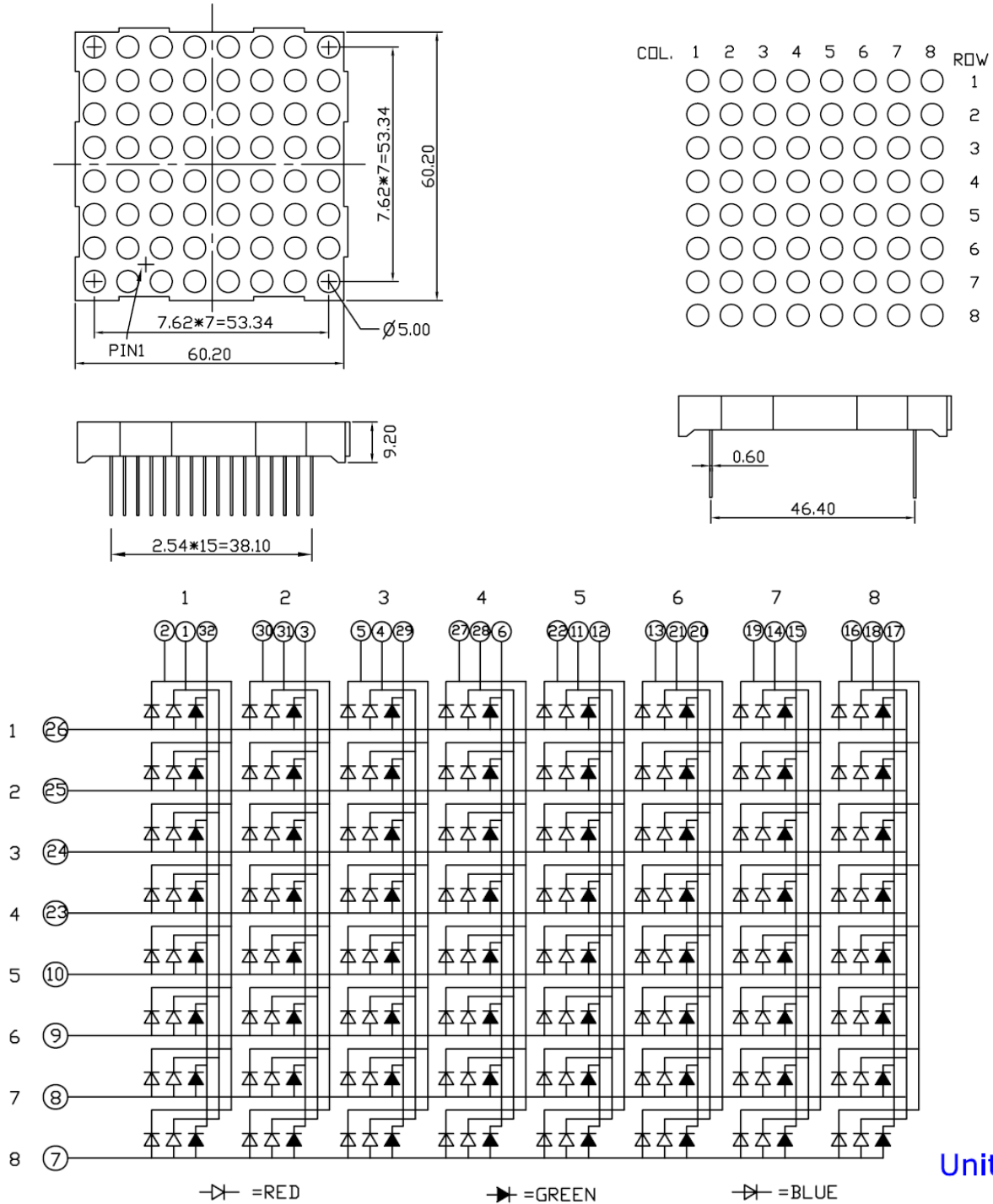

Unit: mm

General Electronics Tech Co., Ltd.

E-Mail: support@geeetech.com MSN: Rockylou84@hotmail.com

Tel: +86 755 2658 4110 Fax: +86 755 2658 4074 Phone: +86 137 2877 2361

Packing Information:

1. Anti-static bag

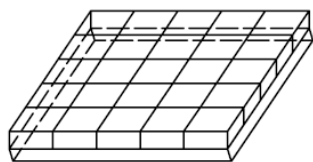

- 96 pcs per layer
- 8x12=96 pcs layer .

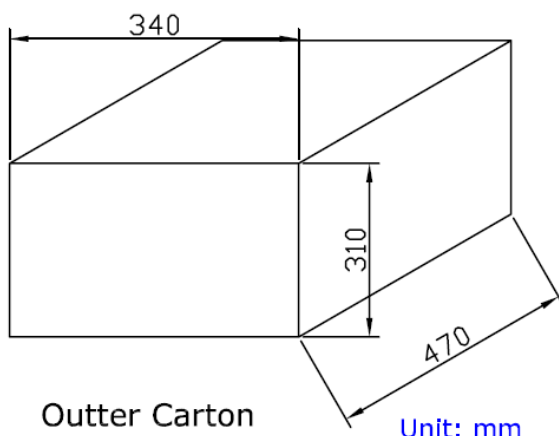
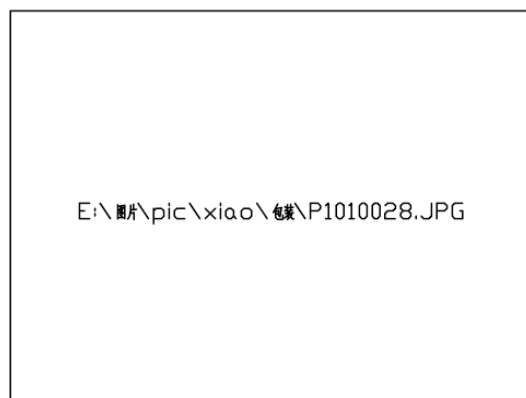
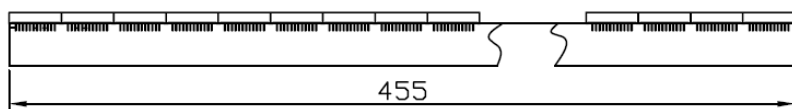
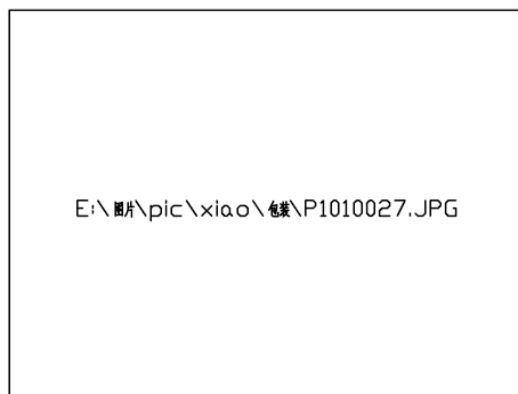

- 8x12=96 pcs layer .
- 12-16 layer per box
- 1152-1536 pcs per box
- 23-26Kg/box

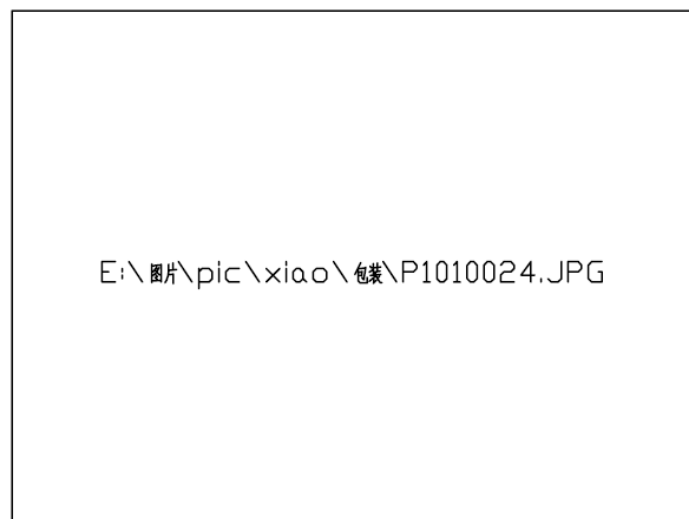

General Electronics Tech Co., Ltd.

E-Mail: support@geeetech.com MSN: Rockylou84@hotmail.com

Tel: +86 755 2658 4110 Fax: +86 755 2658 4074 Phone: +86 137 2877 2361